

PHILIPS

AQ 6350 Cassette Recorder

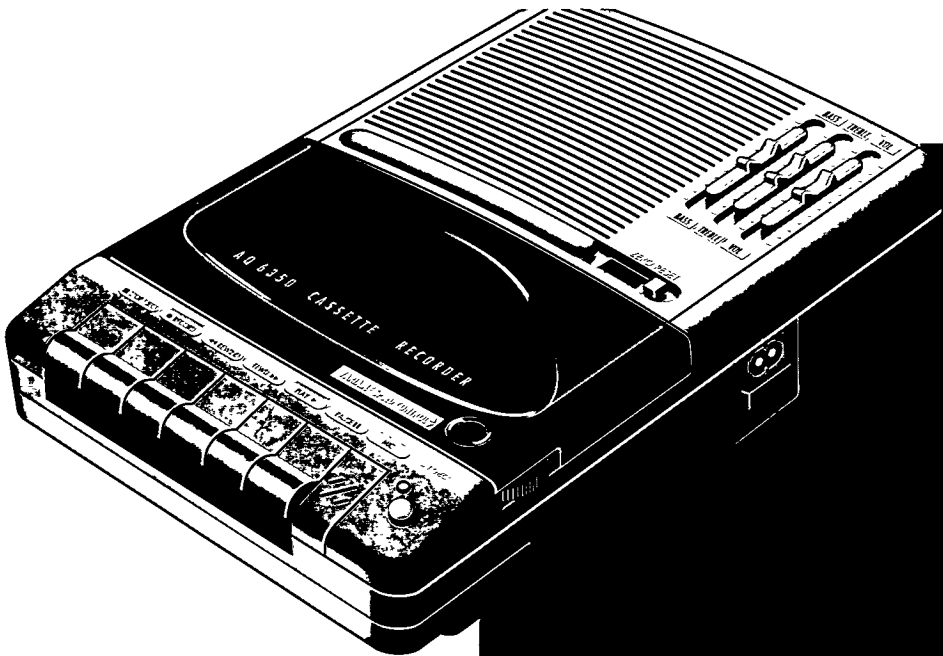

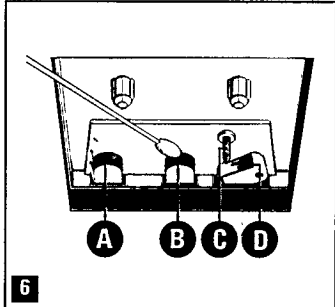
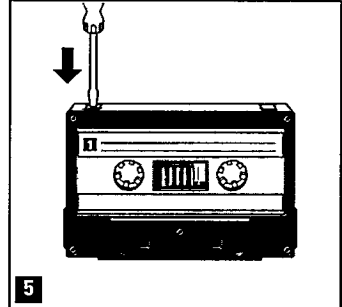
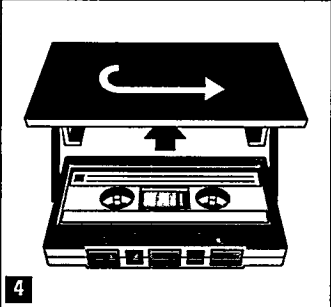
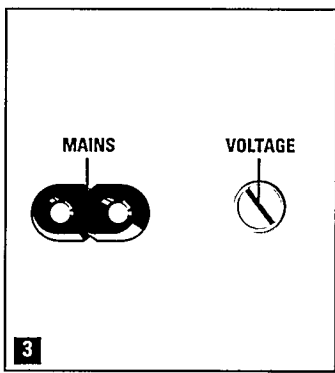
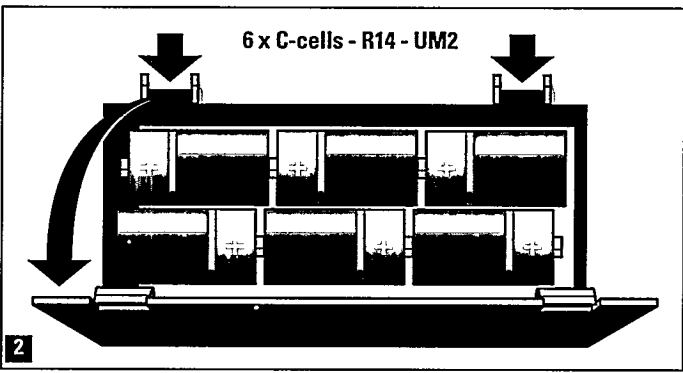
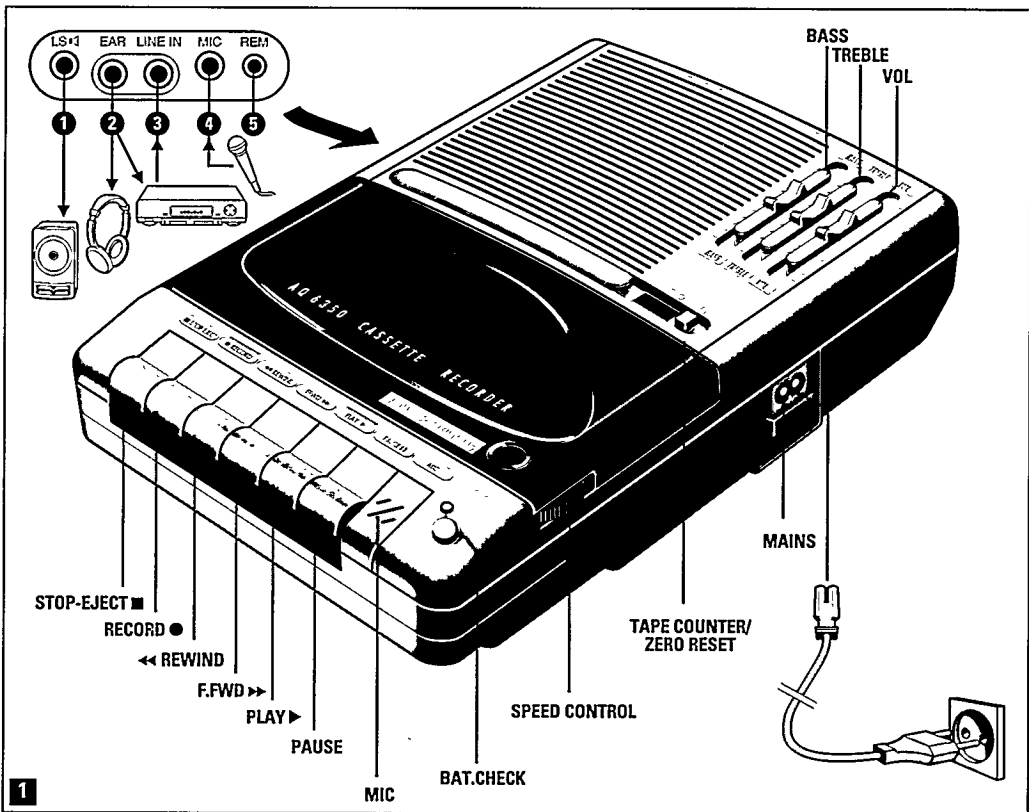

CASSETTE PLAYBACK

During cassette playback the LINE IN socket ③ should not be occupied.

- Press STOP-EJECT ■ and insert a cassette (fig. 4), for playback, any cassette type can be inserted.
- Press PLAY ► and playback will start.
- Adjust the sound with the controls VOL(ume), BASS and TREBLE.
- To vary the the musical pitch of the cassette playback, use the SPEED CONTROL (also see 'SPEED CONTROL').
- To stop, press STOP-EJECT ■.
- The set is then switched off.

Reproduction is possible through:

- the built-in loudspeaker.
- a loudspeaker box connected to the LS socket ①. The recorder loudspeaker is then switched off.
- a headphone connected to the EAR socket ②. The loudspeaker is then switched off.
- an amplifier, radio or recorder connected to the EAR socket ②. The loudspeaker is then switched off.

Important! The EAR 2 output signal is affected by the position of the controls VOL(ume), BASS and TREBLE, so set these controls to their midposition.

SPEED CONTROL

Using SPEED CONTROL, the tape speed of the cassette playback can be changed slightly, in consequence of which the musical pitch and rhythm of the cassette playback will be changed as well.

The SPEED CONTROL is only operative during cassette playback, not during cassette recording.

FAST WINDING AND REWINDING

- Press F(ast) F(or)W(ar)D ►► or ◄◄ REWIND.
- Fast winding/rewinding can be stopped by pressing STOP-EJECT ■.

END OF CASSETTE

When the end of the tape is reached during recording, playback and fast forward winding or rewinding, the pressed recorder buttons will automatically be released.

SAFEGUARD AGAINST ERASURE

- Keep the cassette side to be safeguarded in front of you (fig. 5) and break out the left tab.
- Now recording on this side is not possible any more.
- You can render this safeguard ineffective by covering the aperture now existing with a piece of adhesive tape.

MAINTENANCE

Clean the parts indicated in fig. 6 after every 50 hours of operation or, on average, once a month:

- Open the cassette holder by pressing STOP-EJECT ■.
- Use a cotton bud slightly moistened with alcohol or a special head cleaning fluid.
- Press PLAY ► and clean the rubber pressure roller ④ (fig. 6).
- Then press PAUSE and clean the capstan ⑤, recording/playback head ⑥ and erase head ⑦.
- After cleaning, press STOP-EJECT ■.
- Cleaning of the heads ⑥ and ⑦ can also be done by playing a cleaning cassette through once.

Do not expose the set, batteries and cassettes to rain, moisture, sand, or to excessive heat e.g. from heating equipment or in motor cars parked in the sun.

The type plate is located on the base of the set.

This product complies with the radio interference requirements of the European Community.

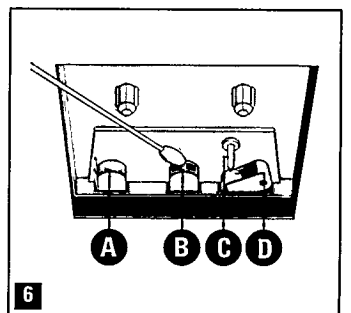
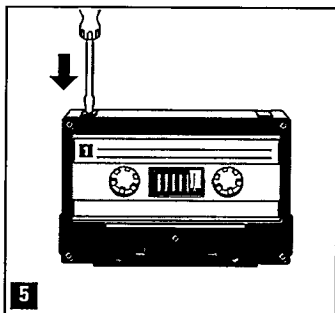
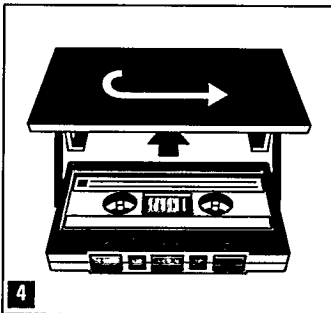
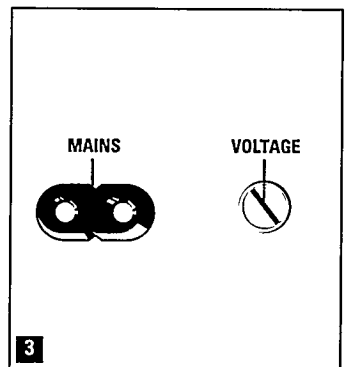
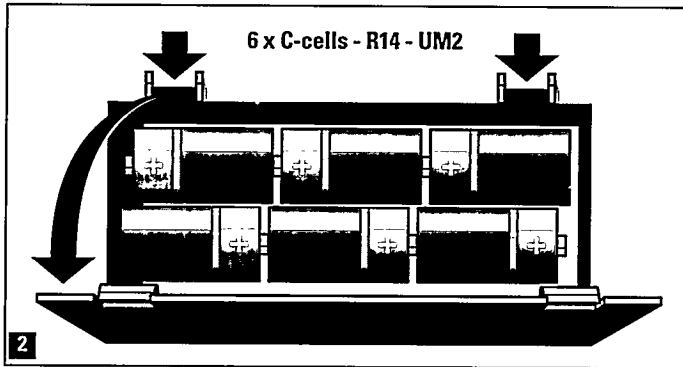
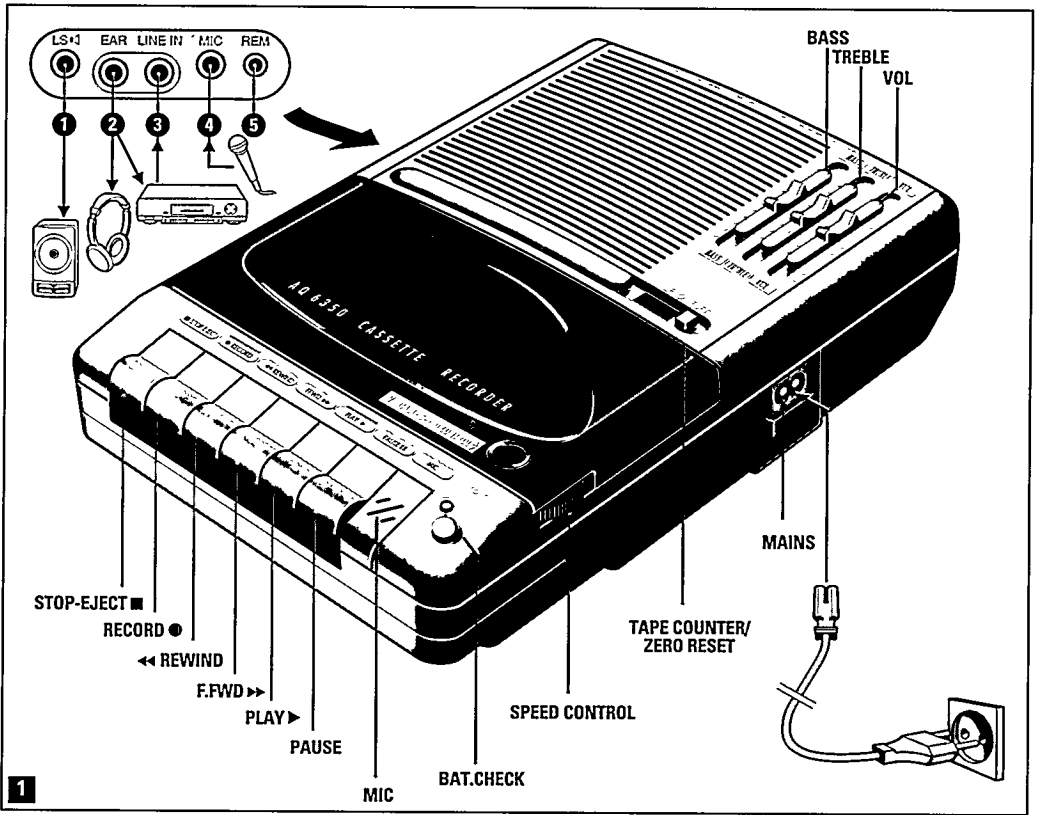

Guarantee and Service valid for Australia

The benefits given to the purchaser by this warranty are in addition to all other rights and remedies, which, under the Trade Practices Act or other Commonwealth or State law, the purchaser or owner has in respect of the product.

The Philips product carries the following warranties:

- C-series HiFi-systems 12 months.
- Compact Disc Players: 12 months.
- Home Audio Systems: 6 months.
- Clock radios, portable radios, cassette recorders, cassette players and radio recorders: 90 days.

Any defect in materials or workmanship occurring within the specified period from the date of delivery, will be rectified free of charge by the retailer from whom this product was purchased.

Note: Please retain your purchase docket to assist prompt service.

Conditions of this warranty

1. All claims for warranty service must be made to the retailer from whom this product was purchased. All transport charges incurred in connection with warranty service or replacement will be paid by the purchaser.
2. These warranties do not cover batteries and extend only to defects in materials or workmanship occurring under normal use of the product where operated in accordance with our instructions.

**Philips Consumer Products Division,
Technology Park,
Figtree Drive, Australia Centre,
Homebush 2140,
New South Wales**

Guarantee and Service for New Zealand

Thank-you for purchasing this quality Philips product.

Philips New Zealand Ltd guarantees this product against defective components and faulty workmanship for a period of 12 months. Any defect in materials or workmanship occurring within 12 months from the date of purchase subject to the following conditions will be rectified free of charge by the retailer from whom this product was purchased.

Conditions

1. The product must have been purchased in New Zealand. As proof of purchase, retain the original sales docket.
2. The guarantee applies only to faults caused by defective components, or faulty workmanship on the part of the manufacturer
3. The guarantee does not cover failures caused by misuse, neglect, normal wear and tear, accidental breakage, use on the incorrect voltage, use contrary to operating instructions, or unauthorised modification to the product or repair by an unauthorised technician.
4. Reasonable evidence (in the form of a sales docket) must be supplied to indicate that the product was purchased no more than 12 months prior to the date of your claim.
5. In the event of a failure, Philips shall be under no liability for any injury, or any loss or damage caused to property or products other than the product under guarantee.

This guarantee does not prejudice your rights under common law and statute, and is in addition to the normal responsibilities of the retailer and Philips.

How to claim

Should your Philips product fail within the guarantee period, please return it to the retailer from whom it was purchased. In most cases the retailer will be able to satisfactorily repair or replace the product.

However, should the retailer not be able to conclude the matter satisfactorily, or if you have other difficulties claiming under this guarantee, please contact

**The Guarantee Controller,
Philips New Zealand Ltd.**

✉ P.O. Box 41.021

Auckland

☎ (09) 84 94 160

☎ (09) 84 97 858

(GB) This sign on the packaging is only meant for Germany.
 (F) Ce signal sur l'emballage concerne uniquement l'Allemagne.
 (D) Dieses Zeichen auf der Verpackung gilt nur für Deutschland.
 (NL) Dit teken op de verpakking geldt alleen voor Duitsland.
 (E) Este símbolo en el embalaje es únicamente para Alemania.
 (P) Este símbolo na embalagem é só para a Alemanha.
 (I) Questo contrassegno sull'imballaggio interessa solo la Germania.
 (DK) Dette mærke har kun betydning i Tyskland.
 (S) Recirkulationsmärket på förpackningen avsedd endast för Tyskland.
 (SF) Tämä merkki pakkauksessa koskee vain Saksaa.

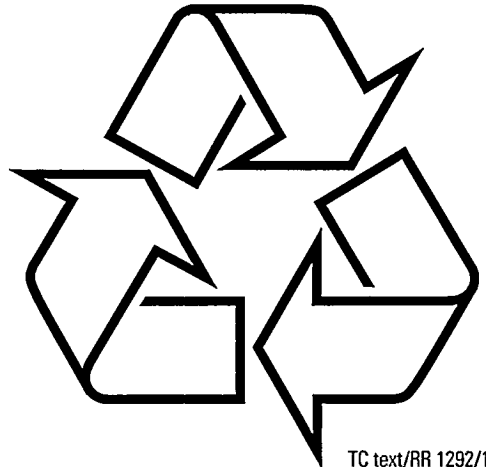

PIKAKELAUS ETEEN JA TAAKSE

- Paina painiketta F(ar)W(ar)D ►► tai ◄◄ REWIND.
- Pysäytä pikakelaus painikkeella STOP-EJECT ■.

KASETIN LOPUTTUA

Kun nauha loppuu tallennuksen, toiston tai pikakelausajan aikana, vapautuvat painetut nauhankuljetuskytkimet automaattisesti.

TALLENTTEEN SUOJAUS

- Jos haluat suojata tahattomalta poispyyhkimiseltä esimerkiksi kasetin 1-puolen, irrota nuolen osoittama kieleke (kuva 5).
- Nyt kasetin 1-puolelle ei voi enää tallentaa.
- Myöhemmin aukko voidaan peittää teipillä, jos kasettia halutaan jälleen käyttää tallennukseen.

HOITO

Puhdista kuvassa 6 näytetyt osat noin 50 käyttötunnin välein tai keskimäärin kerran kuukaudessa.

- Avaa kasettipesä painamalla STOP-EJECT ■-painiketta.
- Kostuta vanupuikko puhdistusspriihin tai magneettipäiden puhdistusaineeseen.
- Paina PLAY ►-painiketta ja pyyhi puristusrulla Ⓞ (kuva 6).
- Paina PAUSE-painiketta ja pyyhi vetoakseli © sekä tallennus/toistopää ⓑ ja poistopää Ⓐ.
- Paina puhdistuksen jälkeen STOP-EJECT ■-painiketta.
- Magneettipäät Ⓐ ja ⓑ voidaan puhdistaa myös käyttämällä puhdistuskasettia.

Suojaa laite, paristot ja kasetit sateelta ja kosteudelta, äläkä jätä niitä pitkäksi aikaa liian kuumaan, esim. aurinkoon pysäköityyn autoon. Laite ei saa olla alttiina tippu- tai roiskevedelle.

*Arvokilpi sijaitseen laitteen pohjassa
Oikeus muutoksiin varataan.*

MEX México

NOM



Es necesario que lea cuidadosamente su instructivo de manejo.
Garantía a la vuelta

DK Danmark

Typeskiltet findes på undersiden af apparaten.
Dette produkt overholder kravene til radio-interferens af Euro-pæisk Fællesskab.
Bemærk: Netafbryderen er sekundært indkoblet og afbryder ikke strømmen fra nettet. Den indbyggede netdel er derfor tilsluttet til lysnettet så længe netstikket sidder i stikkontakten.

N Norge

Typeskilt finnes på apparatens underside.
Observer: Nettbryteren er sekundært innkopleet. Den innebygde nettdelen er derfor ikke frakopleet nettet så lenge apparatet er tilsluttet nettkontakten.

AUS Australia

Guarantee see reverse side

NZ New Zealand

Guarantee see reverse side

SUPPLY

Battery supply

- Open the battery compartment (fig. 2) and insert as indicated six batteries, type R14, UM2 or C-cells.
- The batteries are in good condition as long as the battery indicator lights up:
 - during recording and playback, or
 - when pressing the battery check button (BAT. CHECK). When checking the battery condition, the MAINS socket may not be occupied.
- Remove the batteries if exhausted or if they will not be used again for a long period.
- The battery supply is switched off when the set is connected to the mains. To change over to battery supply, pull out the plug from the MAINS socket.

Mains supply

- Check if the mains voltage as shown on the type plate (on the base of the set) corresponds to your local mains voltage. If it does not, consult your dealer or service organisation.
- If the set is equipped with a VOLTAGE SELECTOR (fig. 3), set this selector to the local mains voltage.
- Connect the mains lead to the MAINS socket and the wall socket (fig. 1 and 3).
- The mains supply is switched on.
- To disconnect the set from the mains completely, withdraw the mains plug from the wall socket..

Important notes for users in the U.K.:**Mains plug**

This apparatus is fitted with an approved moulded 13 Amp plug. To change a fuse in this type of plug proceed as follows:

- Remove fuse cover and fuse.
- Fix new fuse (5 Amp) which should be a BS1362, A.S.T.A. or BSI approved type.
- Refit the fuse cover.

If the fitted plug is not suitable for your socket outlets, it should be cut off and an appropriate plug fitted in its place. If the mains plug contains a fuse, this should have a value of 5 Amp. If a plug without a fuse is used, the fuse at the distribution board should not be greater than 5 Amp.

Note: The severed plug must be disposed to avoid a possible shock hazard should it be inserted into a 13 Amp socket elsewhere.

How to connect a plug

The wires in the mains lead are coloured with the following code: blue = neutral (N), brown = live. (L)

As these colours may not correspond with the colour markings identifying the terminals in your plug, proceed as follows:

- Connect the blue wire to the terminal marked N or coloured black.
- Connect the brown wire to the terminal marked L or coloured red.
- Do not connect either wire to the earth terminal in the plug, marked E (or \perp) or coloured green (or green and yellow).

Before replacing the plug cover, make certain that the cord grip is clamped over the sheath of the lead - not simply over the two wires

RECORDING

Copyright: Recording is permissible insofar as copyright or other rights of third parties are not infringed.

For U.K. only: Recording and playback of material may require consent. See Copyright Act 1956 and The Performer's Protection Acts 1958 to 1972.

Recording possibilities:**from the built-in microphone (MIC)**

Nothing should then be connected to the sockets MIC (4) or LINE IN (3).

Monitoring during microphone recordings is not possible.

from the external microphone socket (MIC (4))

When connecting a microphone, the built-in microphone (MIC) is switched off.

Monitoring during microphone recordings is not possible.

If the microphone is provided with a start/stop remote control, the remote plug may be connected to the socket REM (5). It is then possible to start and stop recording and playback from the microphone, provided the RECORD ● key or the PLAY ► key are pressed the PAUSE key must not be used in this case.

from the LINE IN socket (3)

Connect an amplifier, a radio or recorder to the LINE IN socket (3). The built-in microphone (MIC) is then switched off.

mixing the LINE IN (3) and MIC (4) signals

The signal from the microphone socket (MIC (4)) can be mixed with the LINE IN signal (3).

When monitoring, only the LINE IN signal will be heard.

- Press STOP-EJECT ■ to open the cassette holder.
- Insert the cassette with the full reel on the left (fig. 4) and close the cassette holder.
 - For recording you must use a NORMAL cassette (IEC I) on which the tabs (fig. 5) are not broken out.
 - At the very beginning of the tape, no recording will take place during the first 7 seconds when the leader tape passes the recorder heads.
- Press PAUSE.
- Press RECORD ●, in doing so PLAY ► is automatically pressed too.
- Now start recording by pressing PAUSE again. You can also start recording without using PAUSE; simply press RECORD ● and recording will start.
- The automatic recording level control ensures that all sounds are recorded at the correct level.
- When monitoring during recording, adjust the sound with the controls VOL(ume), BASS and TREBLE; these controls do not affect the recording.
 - Monitoring during microphone recordings is not possible.
- For brief interruptions, press PAUSE; press again to restart recording.
- To stop, press STOP-EJECT ■.
- The set is then switched off; on pressing again, the cassette holder will open.

